

2 · ROW
Cable to Board
Right Angle PTH

.025"

NM, NK

9 thru 91 Contacts

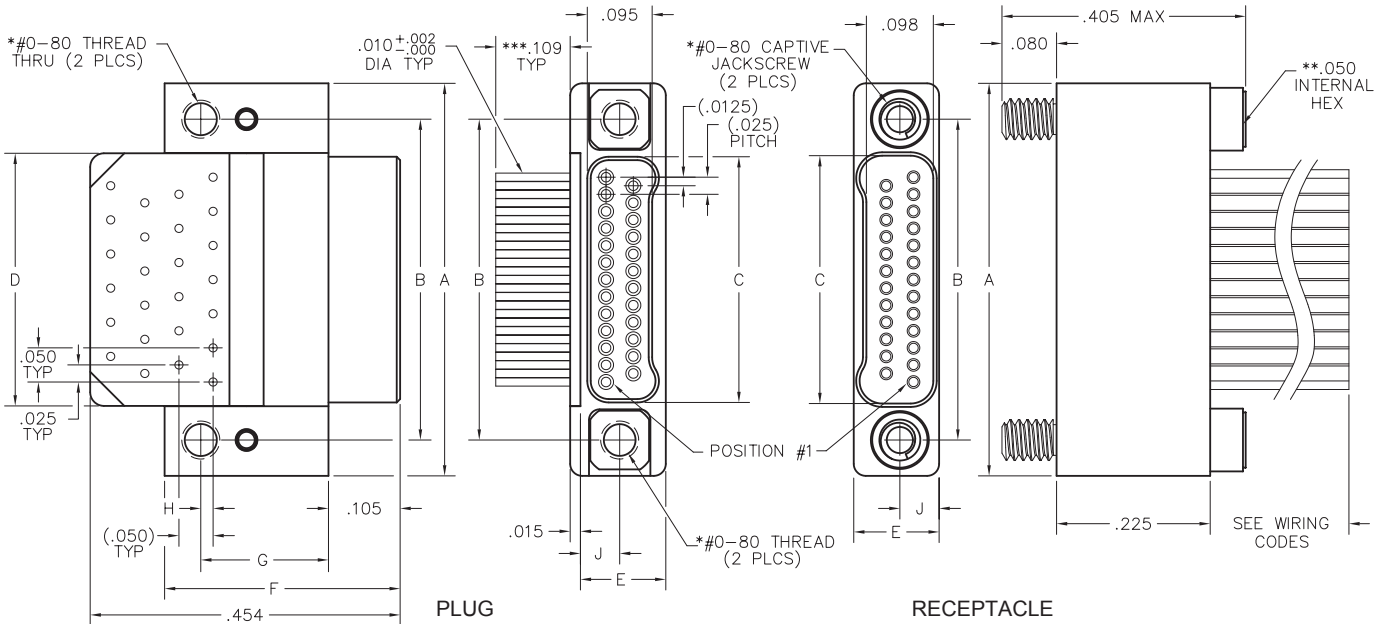
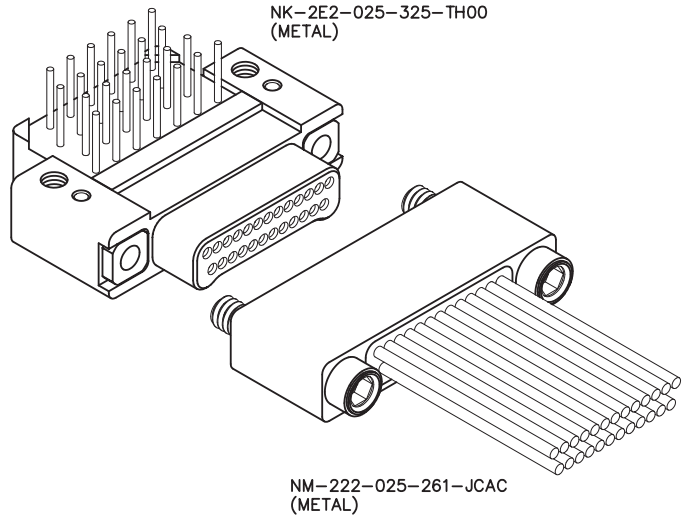

| SIZE | A | B | C | | D | E | F | G | H | J | *HARDWARE |
|------|-------|-------|-------|-------|-------|------|------|------|------|-------|--------------|
| | | | PLUG | RCPT | | | | | | | |
| 9 | .375 | .270 | .160 | .163 | .170 | | | | | | |
| 15 | .450 | .345 | .235 | .238 | .245 | | | | | | |
| 21 | .525 | .420 | .310 | .313 | .320 | | | | | | |
| 25 | .575 | .470 | .360 | .363 | .370 | | | | | | |
| 31 | .650 | .545 | .435 | .438 | .445 | .125 | .345 | .187 | .018 | .0575 | #0-80 THREAD |
| 37 | .725 | .620 | .510 | .513 | .520 | | | | | | |
| 51 | .900 | .795 | .685 | .688 | .695 | | | | | | |
| 65 | 1.075 | .970 | .860 | .863 | .870 | | | | | | |
| 69 | 1.125 | 1.020 | .910 | .913 | .920 | | | | | | |
| 85 | 1.377 | 1.246 | 1.110 | 1.113 | 1.120 | .150 | .410 | .244 | .075 | .0700 | #2-56 THREAD |
| 91 | 1.452 | 1.321 | 1.185 | 1.188 | 1.195 | | | | | | |

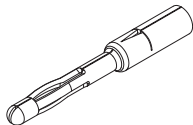

PIN CONTACT
3 TINE SPRING MEMBER, CRIMP

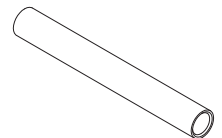

SOCKET CONTACT
DRAWN TUBE, CRIMP

* = #2-56 UNC THREAD ON 85 AND 91 POSITION CONNECTORS.
 ** = 1/16" HEX ON 85 AND 91 POSITION CONNECTORS. HEX MEASUREMENT TAKEN ACROSS THE FLATS.
 *** = OTHER LENGTHS AS REQUIRED

— CLICK HERE —

REQUEST QUOTE

www.geminelec.com

PAGE 1 OF 4 PAGES

(800) 882-6414 | sales@geminelec.com

Recommended PC Board Layout

Right Angle PTH Plug
FOR REFERENCE ONLY

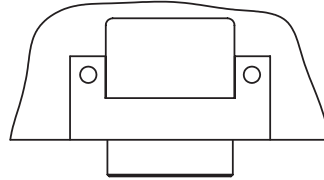

PC BOARD LAYOUT
COMPONENT SIDE

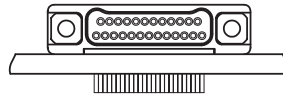
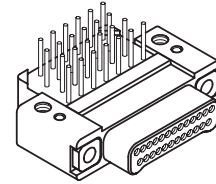

CONNECTOR MATING FACE

9 POSITION

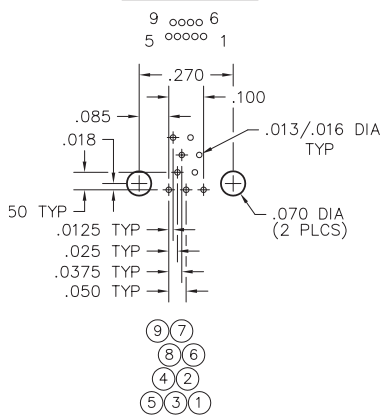

15 POSITION

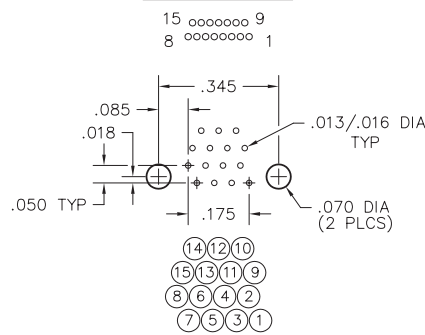

21 POSITION

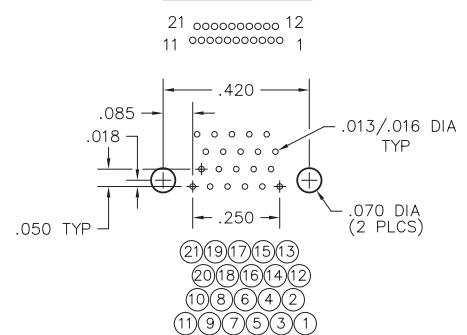

25 POSITION

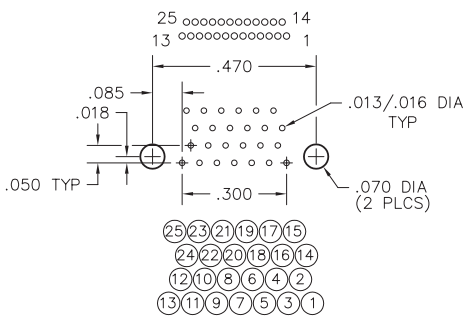

31 POSITION

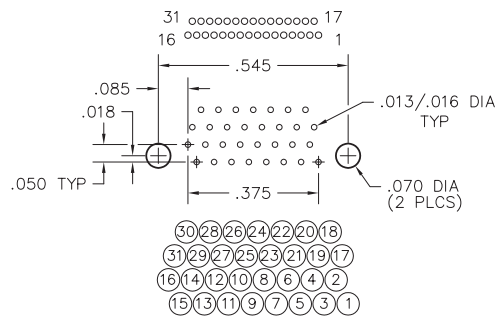

37 POSITION

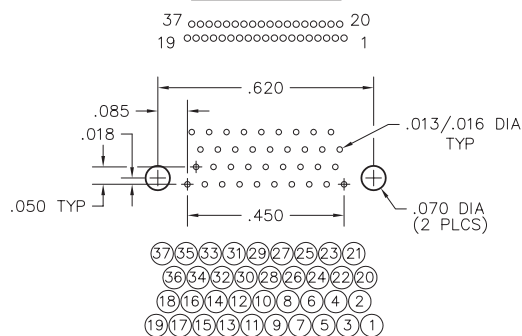

51 POSITION

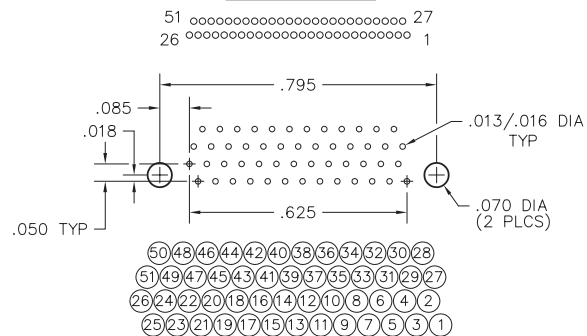

— CLICK HERE —

REQUEST QUOTE

www.geminelec.com

PAGE 2 OF 4 PAGES

(800) 882-6414 | sales@geminelec.com

PLUG: NK-2E2-025-325-TH00
RECEPTACLE: NM-222-025-261-JCAC
XX-XXX-XXX-XXX-XXXX

| PLUG | | RECEPTACLE | |
|------------------------------------|--|------------------------------------|--|
| SERIES | | | |
| NK | .025" Metal PC Board Mounted Connector | NM | .025" Metal I/O Connector |
| BODY | | | |
| 2 | 2-Row | 2 | 2-Row |
| BODY STYLE: | | BODY STYLE: | |
| E | Plug, right angle, plated thru hole (PTH) | 2 | Receptacle, straight |
| | | 6 | Receptacle, straight, with factory installed backshell (See page NA-3) |
| BODY MATERIAL: | | BODY MATERIAL: | |
| 2 | Liquid Crystal Polymer w/ electroless nickel shell | 2 | Liquid Crystal Polymer w/ electroless nickel shell |
| 3 | Liquid Crystal Polymer w/ electrodeposited cadmium shell <input checked="" type="checkbox"/> | 3 | Liquid Crystal Polymer w/ electrodeposited cadmium shell <input checked="" type="checkbox"/> |
| SIZE | | | |
| XXX | Number of contacts (009, 015, 021, 025, 031, 037, 051, 065, 069, 085 or 091) | XXX | Number of contacts (009, 015, 021, 025, 031, 037, 051, 065, 069, 085, or 091) |
| CONTACTS | | | |
| TYPE CONTACTS/TERMINATIONS: | | TYPE CONTACTS/TERMINATIONS: | |
| 32 | Pin, right angle, .109" | 26 | Socket, straight, crimped wire |
| 33 | Pin, right angle, .140" | | |
| 34 | Pin, right angle, .172" | | |
| PLATING OPTIONS: | | PLATING OPTIONS: | |
| 5 | 50 u" Au contacts; Sn/Pb alloy terminations <input checked="" type="checkbox"/> | 1 | 50 u" Au contacts |
| 8 | 50 u" Au contacts; Tin plated terminations | | |
| HARDWARE | | | |
| STYLE OF HARDWARE: | | STYLE OF HARDWARE: | |
| 00 | None | 00 | None |
| TH | Threaded hole, #0-80 UNF* | JC | Turning jackscrews, captivated #0-80 UNF* |
| WIRING OPTIONS: | | WIRING OPTIONS: | |
| 00 | None | XX | See wiring codes, Page NA-2 |

* = #2-56 UNC thread on 85 and 91 position connectors
.050 hex key (#0-80 thread)
1/16" hex key (#2-56 thread)
Recommended torque value 1.0 inch-lbs. max. (#0-80 thread)
Recommended torque value 2.0 inch-lbs. max. (#2-56 thread)
Ball end hex wrench not recommended
Hex wrench key/bit conforming to the requirements of ASME / ANSI-B-18.3 is recommended.
.050" hex L-key long arm wrench - order AirBorn p/n CDG14148.
1/16" hex L-key long arm wrench - order AirBorn p/n CDG14160.

= Option not RoHS compliant

— CLICK HERE —

