

# 2 · ROW Vertical PTH Receptacle with Turning Hardware

.025"

**NK**

9 thru 91 Contacts

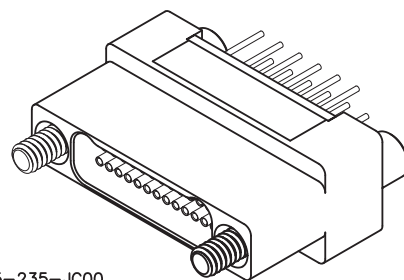
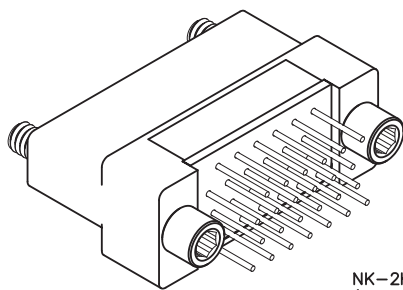

NK-2H2-025-235-JC00  
(RCPT)

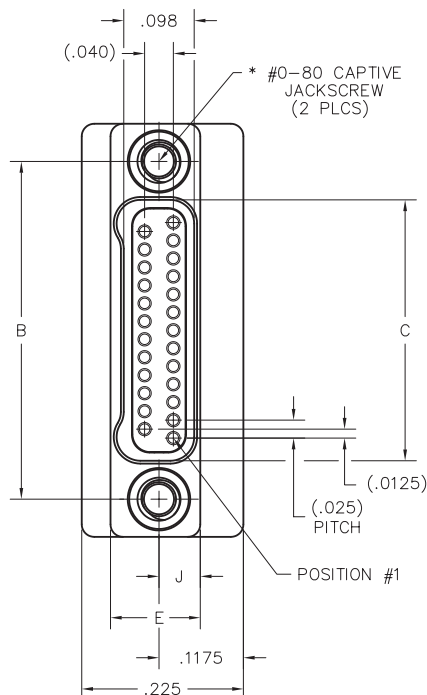
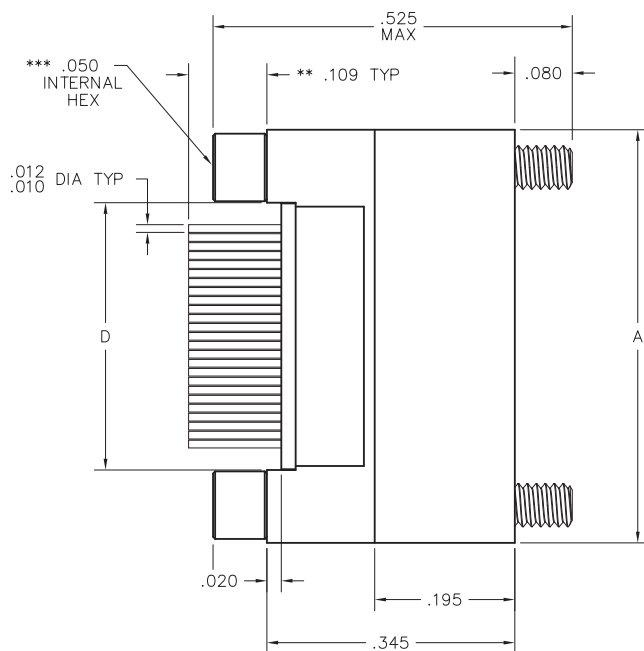

DIMENSIONS							
SIZE	A	B	C	D	E	J	*HARDWARE
9	.375	.270	.163	.170			
15	.450	.345	.238	.245			
21	.525	.420	.313	.320			
25	.575	.470	.363	.370			
31	.650	.545	.438	.445	.125	.0575	#0-80 THREAD
37	.725	.620	.513	.520			
51	.900	.795	.688	.695			
65	1.075	.970	.863	.870			
69	1.125	1.020	.913	.920			
85	1.377	1.246	1.113	1.120	.150	.070	#2-56 THREAD
91	1.452	1.321	1.188	1.197			

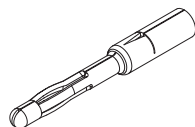

PIN CONTACT  
3 TINE SPRING MEMBER, CRIMP

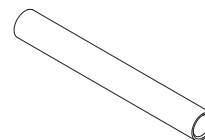

SOCKET CONTACT  
DRAWN TUBE, CRIMP

- \* = #2-56 UNC THREAD ON 85 AND 91 POSITION CONNECTORS.
- \*\* = OTHER LENGTHS AS REQUIRED
- \*\*\* = 1/16" HEX ON 85 POSITION CONNECTORS. HEX MEASUREMENT TAKEN ACROSS THE FLATS.

— CLICK HERE —

**REQUEST QUOTE**

www.geminelec.com

PAGE 1 OF 4 PAGES

(800) 882-6414 | sales@geminelec.com

## Recommended PC Board Layout

Vertical PTH Receptacle with turning hardware FOR REFERENCE ONLY

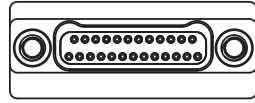

CONNECTOR MATING FACE

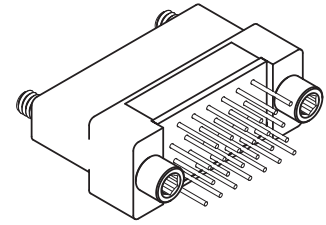

### 9 POSITION

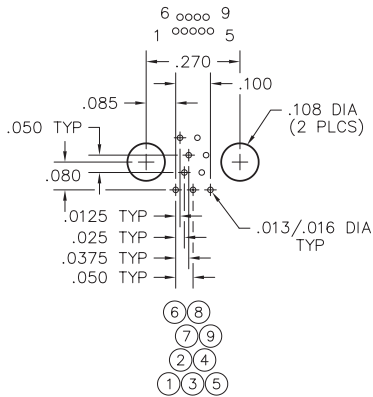

### 15 POSITION

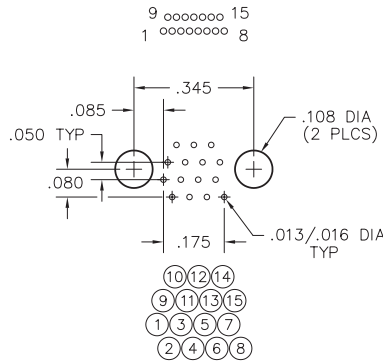

### 21 POSITION

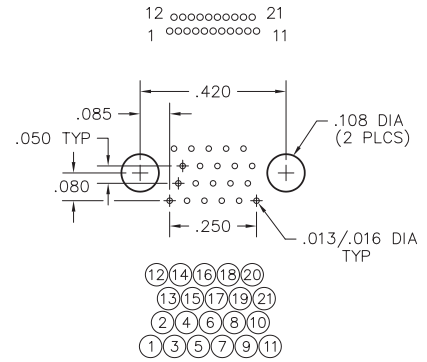

### 25 POSITION

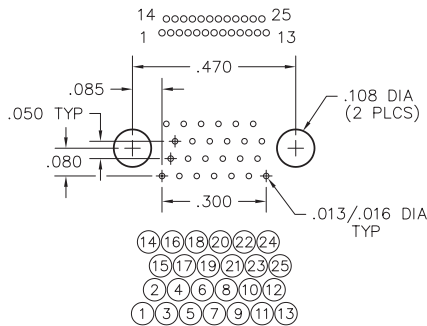

### 31 POSITION

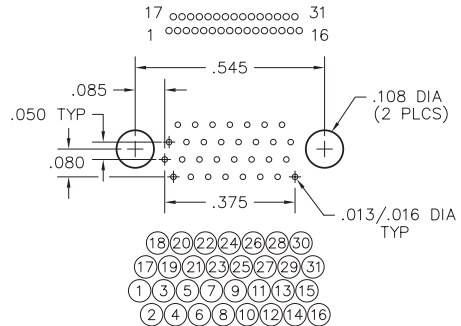

### 37 POSITION

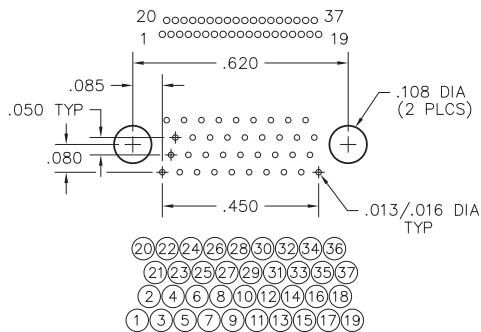

### 51 POSITION

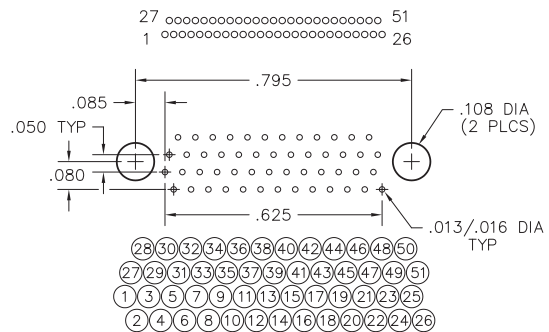

— CLICK HERE —

**REQUEST QUOTE**

www.geminelec.com

PAGE 2 OF 4 PAGES

(800) 882-6414 | sales@geminelec.com

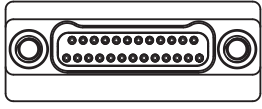

CONNECTOR MATING FACE

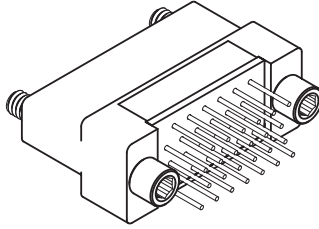

## Recommended PC Board Layout

Vertical PTH Receptacle with turning hardware  
FOR REFERENCE ONLY

### 65 POSITION

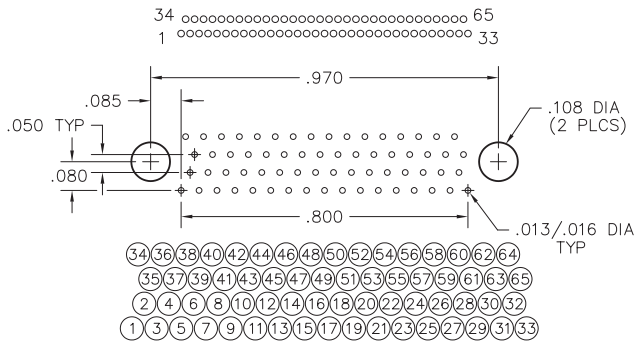

### 69 POSITION

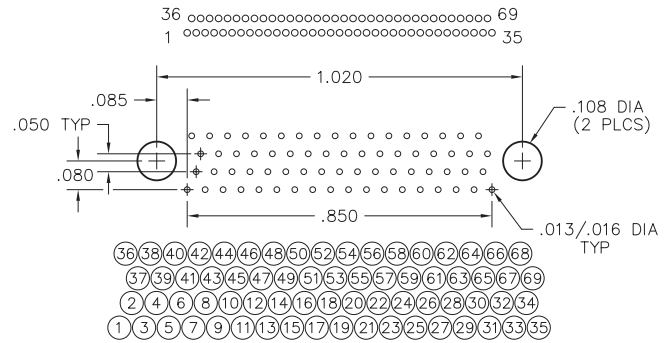

### 85 POSITION

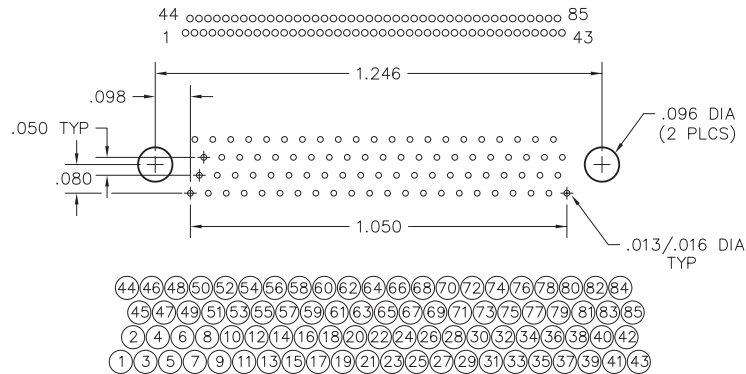

### 91 POSITION

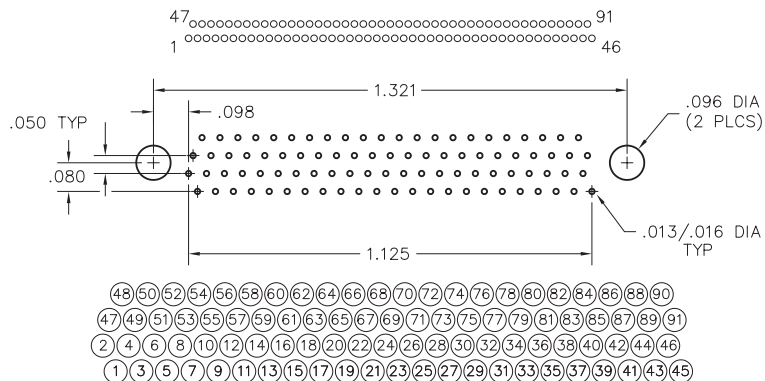

— CLICK HERE —

**REQUEST QUOTE**

[www.geminelec.com](http://www.geminelec.com)

PAGE 3 OF 4 PAGES

(800) 882-6414 | [sales@geminelec.com](mailto:sales@geminelec.com)

NK-2H2-025-235-JC00  
XX-XXX-XXX-XXX-XXXX

**SERIES**

NK .025" Metal PC Board Mounted Connector

**BODY**

2 2-Row

BODY STYLE:  
H Receptacle, vertical mount, plated thru hole (PTH)

BODY MATERIAL:  
2 Liquid Crystal Polymer w/ electroless nickel shell  
3 Liquid Crystal Polymer w/ electrodeposited cadmium shell

**SIZE**

XXX Number of contacts (009, 015, 021, 025, 031, 037, 051, 065, 069, 085 or 091)

**CONTACTS**

TYPE CONTACTS/TERMINATIONS:  
23 Socket, straight, .109"  
24 Socket, straight, .140"  
25 Socket, straight, .172"

PLATING OPTIONS:  
5 50 u" Au contacts; Sn/Pb alloy terminations   
8 50 u" Au contacts; Tin plated terminations

**HARDWARE**

STYLE OF HARDWARE:  
JC #0-80 captive jackscrew \*

WIRING OPTIONS:  
00 None

\* = #2-56 UNC thread on 85 and 91 position connectors  
.050 hex key (#0-80 thread)  
1/16" hex key (#2-56 thread)  
Recommended torque value 1.0 inch-lbs. max. (#0-80 thread)  
Recommended torque value 2.0 inch-lbs. max. (#2-56 thread)  
Ball end hex wrench not recommended  
Hex wrench key/bit conforming to the requirements of ASME / ANSI-B-18.3 is recommended.  
.050" hex L-key long arm wrench - order AirBorn p/n CDG14148.  
1/16" hex L-key long arm wrench - order AirBorn p/n CDG14160.

= Option not RoHS compliant