

2 · ROW

Vertical PTH Plug with Turning Hardware and Mounting Ears

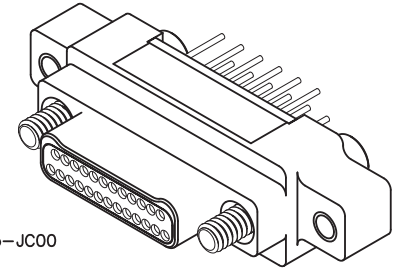
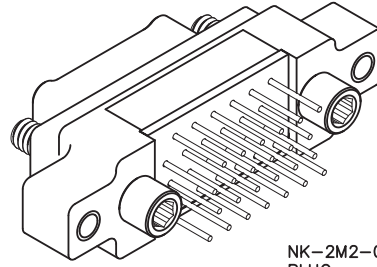

NK-2M2-025-135-JC00
PLUG

.025"

NK

9 thru 85 Contacts

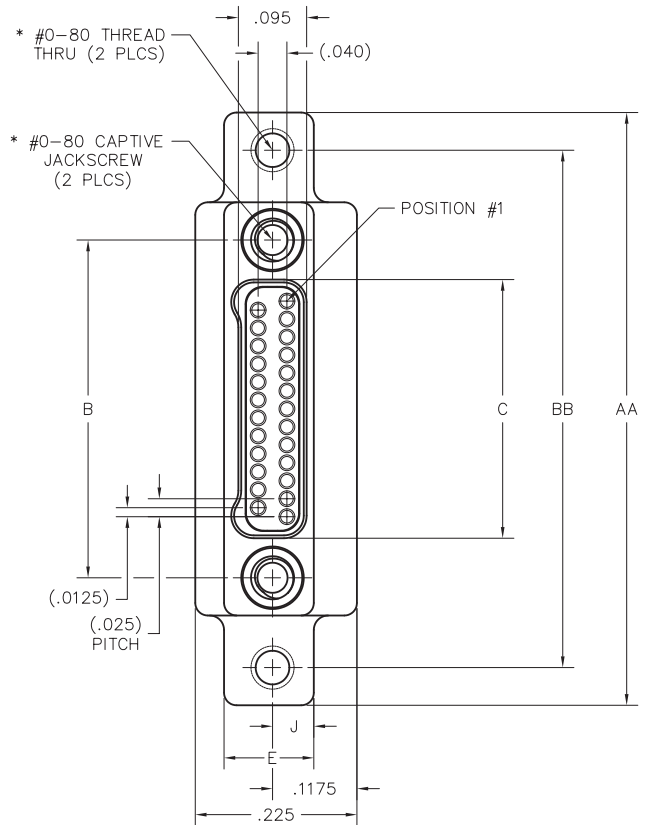
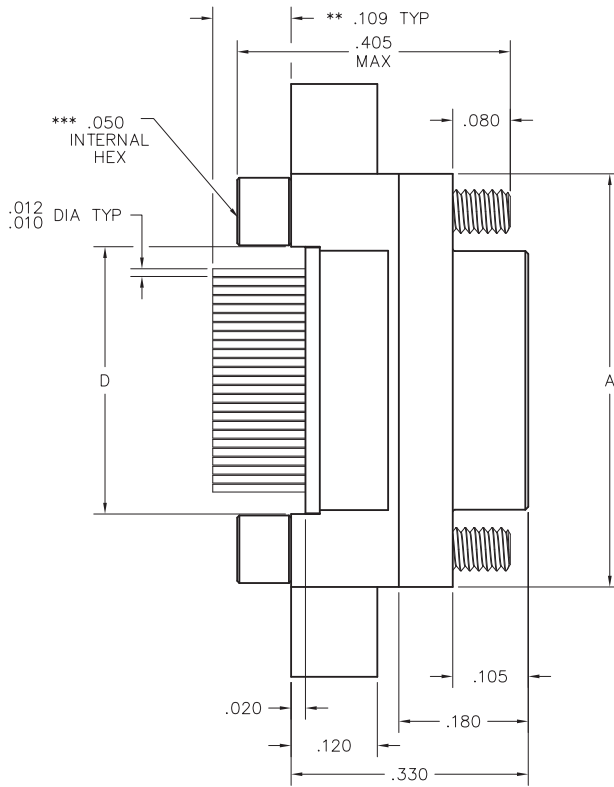

| DIMENSIONS | | | | | | | | | |
|------------|-------|-------|-------|-------|-------|-------|------|-------|--------------|
| SIZE | A | B | AA | BB | C | D | E | J | *HARDWARE |
| 9 | .375 | .270 | .625 | .520 | .160 | .170 | | | |
| 15 | .450 | .345 | .700 | .595 | .235 | .245 | | | |
| 21 | .525 | .420 | .775 | .670 | .310 | .320 | | | |
| 25 | .575 | .470 | .825 | .720 | .360 | .370 | | | |
| 31 | .650 | .545 | .900 | .795 | .435 | .445 | .125 | .0575 | #0-80 THREAD |
| 37 | .725 | .620 | .975 | .870 | .510 | .520 | | | |
| 51 | .900 | .795 | 1.150 | 1.045 | .685 | .695 | | | |
| 65 | 1.075 | .970 | 1.325 | 1.220 | .860 | .870 | | | |
| 69 | 1.125 | 1.020 | 1.375 | 1.270 | .910 | .920 | | | |
| 85 | 1.377 | 1.246 | 1.679 | 1.546 | 1.110 | 1.120 | .150 | .070 | #2-56 THREAD |

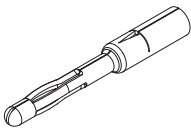

PIN CONTACT
3 TINE SPRING MEMBER, CRIMP

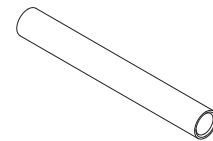

SOCKET CONTACT
DRAWN TUBE, CRIMP

* = #2-56 UNC THREAD ON 85 POSITION CONNECTORS.
 ** = OTHER LENGTHS AS REQUIRED
 *** = 1/16" HEX ON 85 POSITION CONNECTORS. HEX MEASUREMENT TAKEN ACROSS THE FLATS.

— CLICK HERE —

REQUEST QUOTE

www.geminelec.com

PAGE 1 OF 4 PAGES

(800) 882-6414 | sales@geminelec.com

Recommended PC Board Layout

Vertical PTH Plug with turning hardware and mounting ears
FOR REFERENCE ONLY

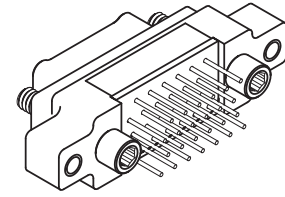
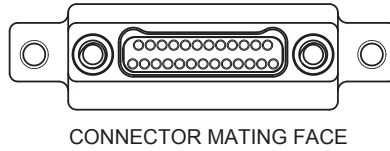

9 POSITION

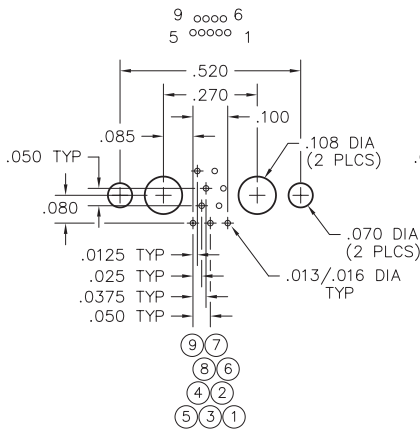

15 POSITION

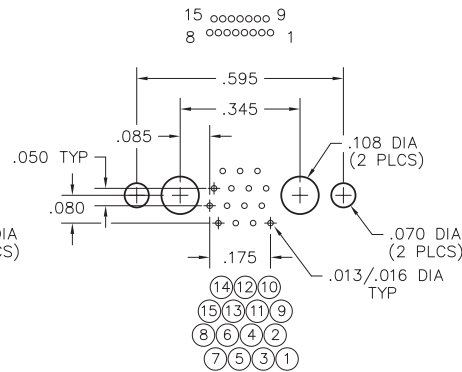

21 POSITION

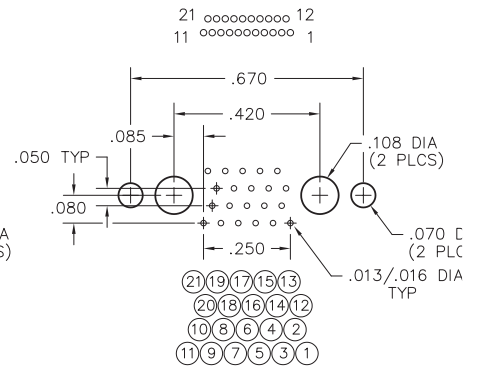

25 POSITION

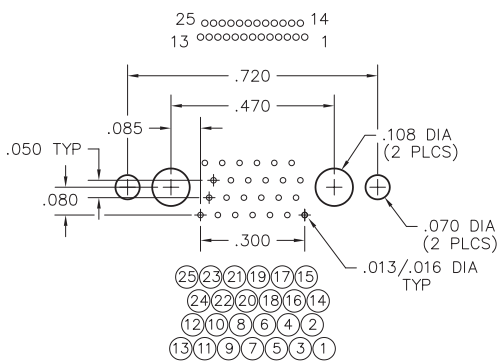

31 POSITION

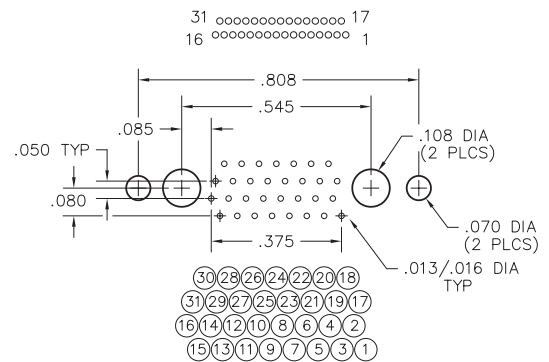

37 POSITION

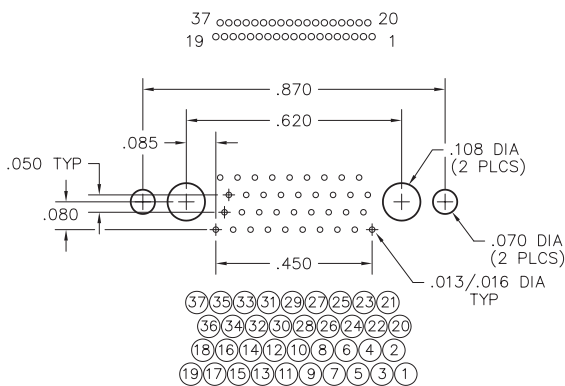

51 POSITION

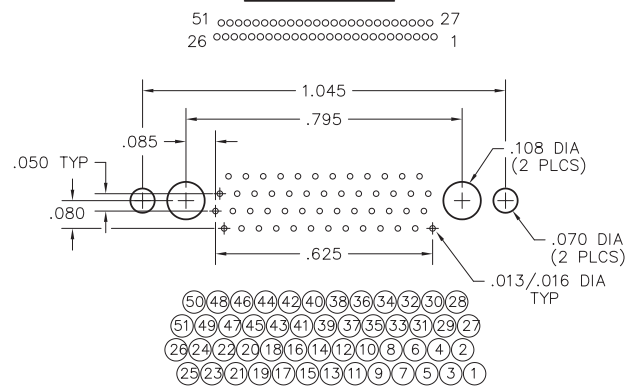

— CLICK HERE —

REQUEST QUOTE

www.geminelec.com

PAGE 2 OF 4 PAGES

(800) 882-6414 | sales@geminelec.com

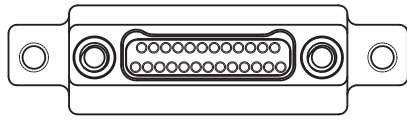

CONNECTOR MATING FACE

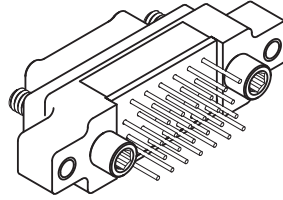

Recommended PC Board Layout

Vertical PTH Plug
with turning hardware
and mounting ears
FOR REFERENCE ONLY

65 POSITION

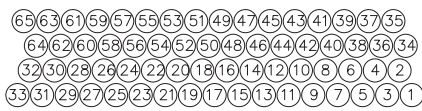
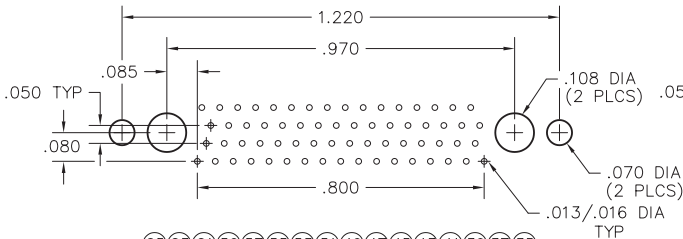
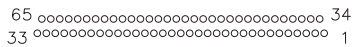

69 POSITION

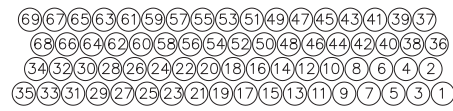
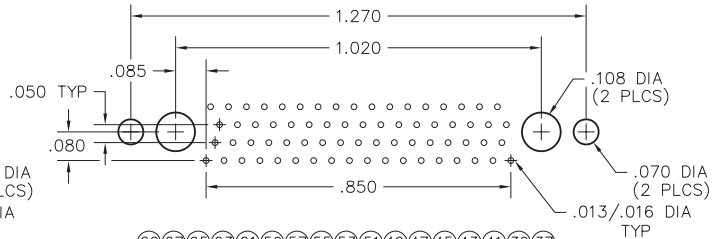
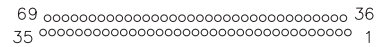

85 POSITION

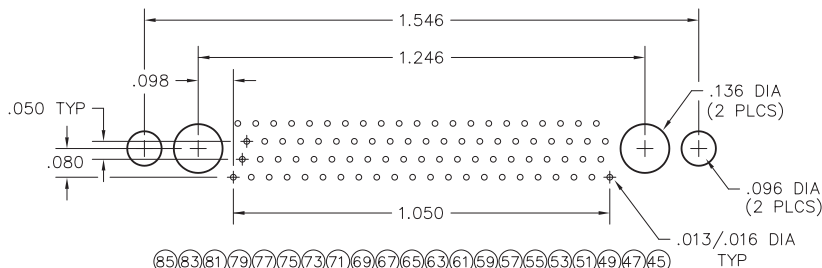
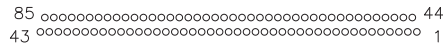

NK-2M2-025-135-JC00
XX-XXX-XXX-XXX-XXXX

SERIES

NK .025" Metal PC Board Mounted Connector

BODY

2 2-Row

BODY STYLE:

M Plug, vertical mount, plated thru hole (PTH) with mounting ears

BODY MATERIAL:

- 2 Liquid Crystal Polymer w/ electroless nickel shell
- 3 Liquid Crystal Polymer w/ electrodeposited cadmium shell

SIZE

XXX Number of contacts (009, 015, 021, 025, 031, 037, 051, 065, 069 or 085)

CONTACTS

TYPE CONTACTS/TERMINATIONS:

- 13 Pin, straight, .109"
- 14 Pin, straight, .140"
- 15 Pin, straight, .172"

PLATING OPTIONS:

- 5 50 u" Au contacts; Sn/Pb alloy terminations
- 8 50 u" Au contacts; Tin plated terminations

HARDWARE

STYLE OF HARDWARE:

JC #0-80 captive jackscrew *

WIRING OPTIONS:

00 None

* = #2-56 UNC thread on 85 position connectors

- .050 hex key (#0-80 thread)
- 1/16" hex key (#2-56 thread)

Recommended torque value 1.0 inch-lbs. max. (#0-80 thread)

Recommended torque value 2.0 inch-lbs. max. (#2-56 thread)

Ball end hex wrench not recommended

Hex wrench key/bit conforming to the requirements of ASME / ANSI-B-18.3 is recommended.

.050" hex L-key long arm wrench - order AirBorn p/n CDG14148.

1/16" hex L-key long arm wrench - order AirBorn p/n CDG14160.

= Option not RoHS compliant