

**Cable to Board
(Standard Footprint)**

.050"
9 thru 100 Contacts
Rugged Cable

MM, MN

Rugged Board Mount

MK, ML

MM-322-051-261-45WP
(METAL)

MN-321-051-261-45WP
(PLASTIC)

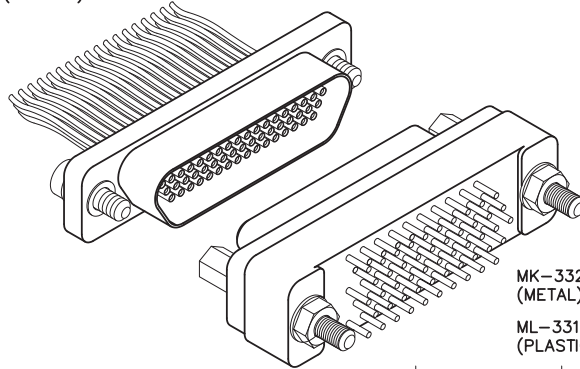

MK-332-051-125-2200
(METAL)

ML-331-051-125-2200
(PLASTIC)

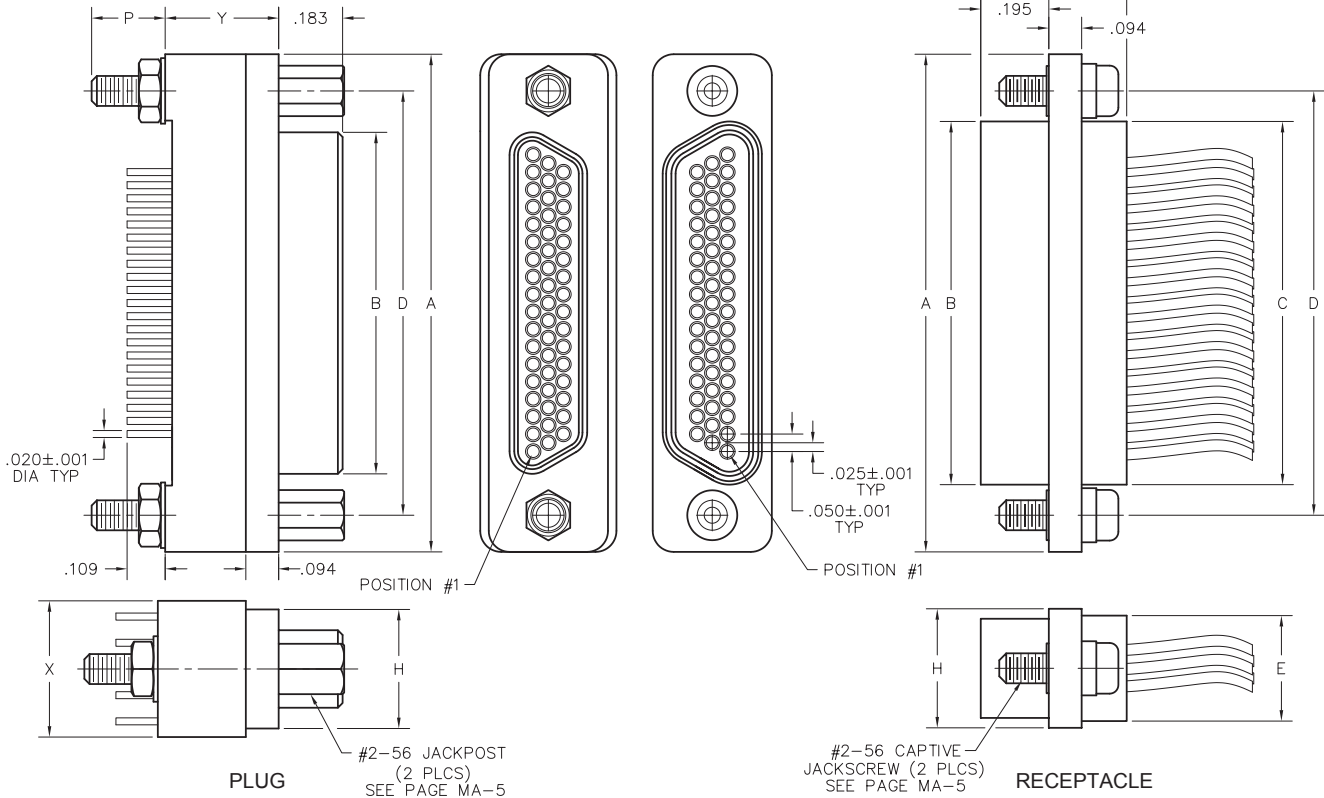

SIZE	CONTACT ROWS	DIMENSIONS										HARDWARE	
		A	B		C	D	E	H	P	X	Y		Z***
			PLUG MAX	RCPT MAX			POTTING WELL MAX						
9	2	.775	.334	.400	.390	.565	.270	.298	.210	.298	.280	.390	#2-56 UNC THD (.092 DIA THRU OR #2-56 UNC THREADED INSERT)
15		.925	.484	.550	.540	.715						.540	
21		1.075	.634	.700	.690	.865						.690	
25		1.175	.734	.800	.790	.965						.780	
31		1.325	.884	.950	.940	1.115						.930	
37		1.475	1.034	1.100	1.090	1.265	.214	.330**	1.080				
51	3	1.425	.984	1.050	1.040	1.215	.310	.341	.219	.390	.325	1.046	#4-40 UNC THD (.147 DIA THRU OR #4-40 UNC THREADED INSERT)
69		1.725	1.284	1.350	1.340	1.515						1.346	
100		2.160	1.384	1.508	1.432	1.800						.360	

* = 69 POSITION CONNECTORS ARE AVAILABLE IN METAL ONLY.
** = 37 POSITION WITH TURNING HARDWARE "Y" DIMENSION IS .280.
*** = "Z" DIMENSION FOR TURNING JACKSCREW ONLY

— CLICK HERE —

REQUEST QUOTE

www.geminelec.com

PAGE 1 OF 8 PAGES

(800) 882-6414 | sales@geminelec.com

Polarized Keying Hardware



Select the appropriate two digit number above and include as the last two digits of the hardware code in the part number.
(Keying hardware is factory installed and non-removable).

Example:

MM-213-025-161-99WA-KS11

MK-263-025-435-990S-KP11

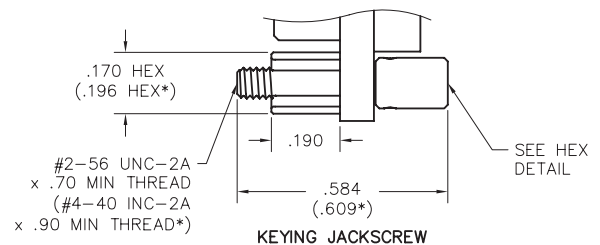
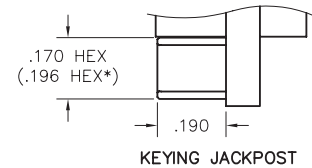
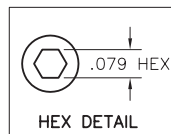
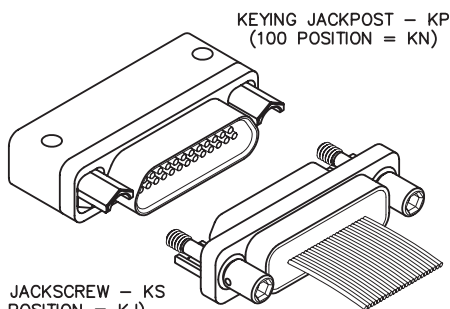

* = Dimensions for 100 position connectors

— CLICK HERE —

REQUEST QUOTE

www.geminelec.com

PAGE 2 OF 8 PAGES

(800) 882-6414 | sales@geminelec.com

PLUG: MK-332-051-125-2200
RECEPTACLE: MM-322-051-261-45WP
PLUG: ML-331-051-125-2200
RECEPTACLE: MN-321-051-261-45WP
XX-XXX-XXX-XXX-XXXX-XXX

PLUG	RECEPTACLE
SERIES	
MK .050" Rugged Metal PC Board Mount Connector ML .050" Rugged Plastic PC Board Mount Connector (MK & ML mate with MK, ML, MM, MN receptacles)	MM .050" Rugged Metal I/O Connector MN .050" Rugged Plastic I/O Connector (MM & MN mate with MK, ML, MM, MN plugs)
BODY	
2 2-Row (Sizes 9 thru 37) 3 3-Row (Size 51 & 69***) 4 4-Row (Size 100)	2 2-Row (Sizes 9 thru 37) 3 3-Row (Size 51 & 69***) 4 4-Row (Size 100)
BODY STYLE: 3 Plug, straight, standard footprint	BODY STYLE: 2 Receptacle, straight, with ears
BODY MATERIAL: 1 Polyphenylene Sulfide (ML only) 2 Polyphenylene Sulfide with electroless nickel shell 3 Polyphenylene Sulfide with electrodeposited cadmium shell <input checked="" type="checkbox"/> 4 Polyphenylene Sulfide with hard anodized black shell 5 Polyphenylene Sulfide with stainless steel shell	BODY MATERIAL: 1 Polyphenylene Sulfide (MN only) 2 Polyphenylene Sulfide with electroless nickel shell 3 Polyphenylene Sulfide with electrodeposited cadmium shell <input checked="" type="checkbox"/> 4 Polyphenylene Sulfide with hard anodized black shell 5 Polyphenylene Sulfide with stainless steel shell
SIZE	
XXX 009, 015, 021, 025, 031, 037, 051, 069***, 100	XXX 009, 015, 021, 025, 031, 037, 051, 069***, 100
CONTACTS	
TYPE CONTACTS/TERMINATIONS: 12 Pin, straight, PCB leads, .109" 13 Pin, straight, PCB leads, .140" 14 Pin, straight, PCB leads, .172"	TYPE CONTACTS/TERMINATIONS: 21 Socket, straight, solder cup 24 Socket, straight, .500" pigtails (.018 dia) 25 Socket, straight, 1.000" pigtails (.018 dia) 26 Socket, straight, crimped wire
PLATING OPTIONS: 3 50 μ" Au contacts; 10 μ" Au terminations 5 50 μ" Au contacts; Sn/Pb alloy terminations <input checked="" type="checkbox"/> 7 50 μ" Au contacts; SAC305 terminations	PLATING OPTIONS: 1 50 μ" Au contacts (crimp wire) 3 50 μ" Au contacts; 10 μ" Au terminations (solder cup, pigtail) 5 50 μ" Au contacts; Sn/Pb alloy terminations (pigtail) <input checked="" type="checkbox"/> 7 50 μ" Au contacts; SAC305 terminations (pigtail)
HARDWARE	
STYLE OF HARDWARE: 00 None 22 Two fixed jacknut assemblies (62*) 41 Two turning jackscrews, allen head, retaining ring**** (81*) 99 Keying hardware, see options below (Body material 2, 3 and 4 only)	STYLE OF HARDWARE: 00 None 22 Two fixed jacknut assemblies (62*) 41 Two turning jackscrews, allen head, retaining ring (81*) 42 Two long turning jackscrews, allen head, retaining ring (82*) 43 Two turning jackscrews, slot head, retaining ring (83*) 44 Two long turning jackscrews, slot head, retaining ring (84*) 45 Two turning jackscrews, allen head, captivated** (85*) 99 Keying hardware, see options below (Body material 2, 3 and 4 only)
POLARIZATION / WIRING: 00 None	POLARIZATION / WIRING: 00 None XX For wiring codes, see page MA-3 & MA-4
OPTIONS	
KPXX Two fixed jacknuts. See page MA-6 for keying options (KN*) 0B7 Threaded inserts	KSXX Two turning jackscrews and interfacial sealing gasket. See page MA-6 for keying options (KJ*) 900 Interfacial sealing gasket

* = Use numbers or letters in parenthesis when ordering size 100.

** = Captive hardware is factory installed and non-removable.

*** = 69 position connectors are available in metal only.

**** = Connector body has no mounting holes.

= Option not RoHS compliant

— CLICK HERE —

Recommended PC Board Layout

Straight, Standard Footprint

CONNECTOR
MATING FACE
(PLUG)

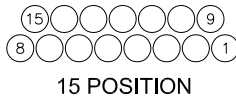
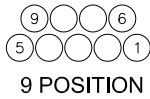

PLUG
PC BOARD LAYOUT
COMPONENT SIDE

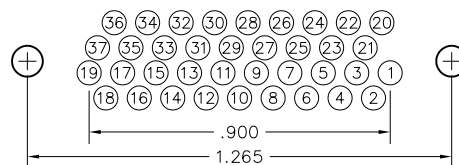
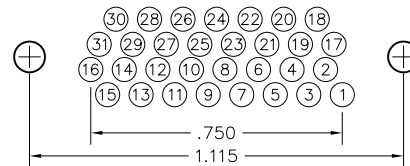
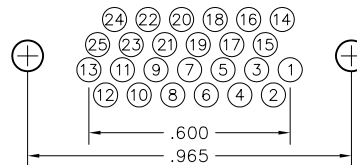
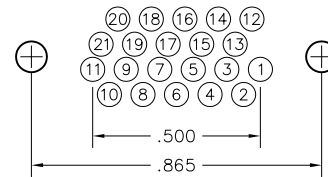
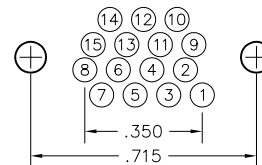
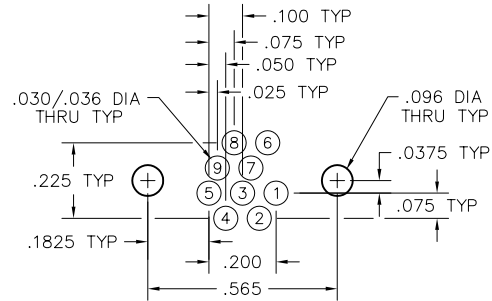

— CLICK HERE —

REQUEST QUOTE

www.geminelec.com

PAGE 4 OF 8 PAGES

(800) 882-6414 | sales@geminelec.com

Recommended PC Board Layout

Straight, Standard Footprint

CONNECTOR MATING FACE (PLUG)

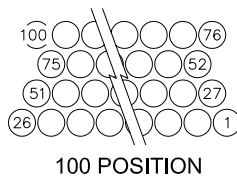
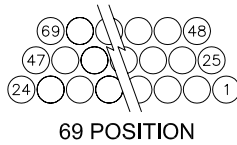
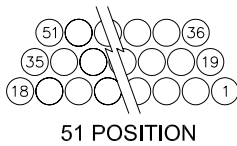

PLUG PC BOARD LAYOUT COMPONENT SIDE

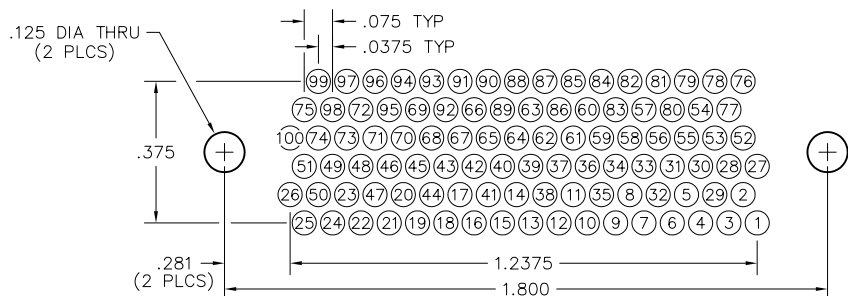
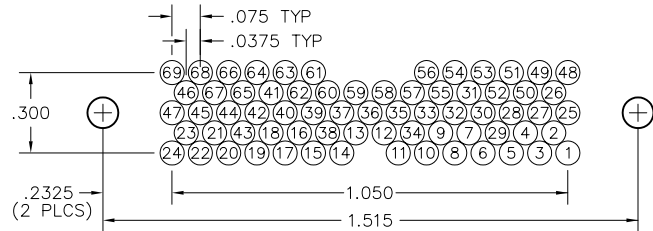
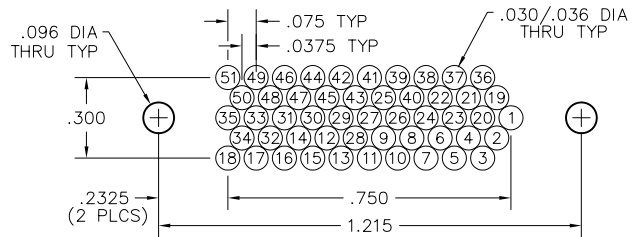

Mating Matrix for AirBorn "M" Series Connectors

RECEPTACLES

**P
L
U
G
S**

	MA (Strip)	MC (Circular)	MM (Hybrid)	MK (Metal) PC Board	ML (Plastic) PC Board	MM (Metal) I/O	MN (Plastic) I/O	MP (Plastic) I/O	MQ (Metal) I/O	MR (Plastic) PC Board	MS (Metal) PC Board
MA (Strip)	XX										
MC (Circular)		XX									
MM (Hybrid)			XX								
MK (Metal) PC Board				BB	BB	BI	BI				
ML (Plastic) PC Board				BB	BB	BI	BI				
MM (Metal) I/O				IB	IB	II	II				
MN (Plastic) I/O				IB	IB	II	II				
MP (Plastic) I/O								II	II	IB	IB
MQ (Metal) I/O								II	II	IB	IB
MR (Plastic) PC Board								BI	BI	BB	BB
MS (Metal) PC Board								BI	BI	BB	BB

I/O Connectors

MM-MN-MP-MQ

PC Board Mounted Connectors

MK-ML-MR-MS

Inter-mateable Connectors

MK-ML-MM-MN
MP-MQ-MR-MS

KEY:

BB = PC Board Mounted Plug with PC Board Mounted Receptacle

BI = PC Board Mounted Plug with I/O Receptacle

IB = I/O Plug with PC Board Mounted Receptacle

II = I/O Plug with I/O Receptacle

For Military Configurations, See pages MIL-1 thru MIL-22

— CLICK HERE —

REQUEST QUOTE

Specifications

Materials and Finishes *

Contacts:	Pins: BeCu alloy strip per ASTM B194 Sockets: Brass per ASTM B121 / B121M or ASTM B16 / B16M or ASTM B453
Contact Finish:**	Gold plate per ASTM B488
Shells:	Aluminum Alloy 6061-T6 per SAE AMS-QQ-A-250/11 or 6061-T6511 per SAE AMS-QQ-A-200/8 or Stainless Steel 300 series per ASTM A484 / A484M and ASTM A582 / A582M Passivated per SAE AMS2700
Aluminum Shell Finishes:**	Electroless Nickel per SAE AMS2404 Electrodeposited Cadmium per SAE AMS-QQ-P-416 Black Anodized per MIL-A-8625 Gold per MIL-DTL-45204
Molded Insulators:	Glass filled polyphenylene sulfide per MIL-M-24519
Embedment:	Insulating compound per MIL-I-16923
Jackscrews, Jackposts and Nuts:	Corrosion resistant steel per ASTM A320 or ASTM A484 / A484M and ASTM A582 / A582M Passivated per SAE AMS2700
Clips and Washers:	Corrosion resistant steel per ASME 18.24 or NASM35333 Passivated per ASME 18.24 or NASM35333
Guide Pins	Corrosion resistant steel per ASTM A484 / A484M and ASTM A582 / A582M Passivated per SAE AMS2700
Latches	Beryllium copper in accordance with ASTM B194 Electroless Nickel plate per SAE AMS2404
Interfacial Seal Gaskets:	Fluorosilicone per SAE AMS-R-25988
Tolerances:**	Unless otherwise specified: Fractions = $\pm 1/64$ " Decimals = ± 0.010 " Angles = $\pm 5^\circ$ Wire lengths: insulated/stranded = $+1.0"/-0.0$ " uninsulated/solid = $+0.2"/-0.0$ "

Note: AirBorn can manufacture special configurations for your exact specifications.

* = Reference the above listed specifications or an equivalent industry standard when applicable

** = When ordering to Mil Spec P/N, Mil Spec requirements apply

Performance

Reference MIL-DTL-83513

AirBorn "M" Series meets or exceeds MIL-DTL-83513 Performance Specifications

Contact Rating:	3-amperes maximum
Solderability:	Terminals (except crimp) tested in accordance with MIL-STD-202, Method 208
Wire Size:	Stranded #26 AWG or solid #25 AWG standard (consult factory for other sizes and types)
Test Voltage:	600 V, RMS, 60 Hz
Operating Temperature:	-55° C to +125° C
Insulation Resistance:	5,000 megohms minimum @ 500 VDC
Durability:	500 connector mating cycles
Vibration:	Tested in accordance with MIL-STD-1344, Method 2005, Condition IV, according to MIL-83513
Shock:	Tested in accordance with MIL-STD-1344, Method 2004, Condition E, according to MIL-83513
Salt Spray:	Mated connectors tested in accordance with MIL-STD-1344, Method 1001, Test Condition B
Humidity:	Mated connectors tested in accordance with MIL-STD-1344, Method 1002, Type II (except steps 7a and 7b)
Thermal Shock:	Tested to the temperature extremes of MIL-STD-1344, Method 1003, Test Condition A (except step 3, temperature shall be 125° C)
Contact Resistance:	0.065 volt maximum drop @ 2.5 amps (.026 ohms)
Contact Engaging Force:	6.0 ounce maximum, with .0221 diameter test sleeve per contact
Contact Separating Force:	0.5 ounce minimum, with .0230 diameter test sleeve per contact
Crimp Strength:	5 pound minimum tensile strength
Mating & Unmating Force:	10 ounces maximum per contact

— CLICK HERE —

REQUEST QUOTE

www.geminelec.com

PAGE 8 OF 8 PAGES

(800) 882-6414 | sales@geminelec.com